



ProPower Series™ Speakers

PS112

Two-Way Speaker

Congratulations!

You have just purchased one of the finest speakers on the market today. The ProPower Series™ was developed using the expertise of professional sound engineers and working musicians. You will find your new NADY AUDIO speaker has superior performance and greater flexibility than any other speaker in its price range.

We recommend that you read this instruction sheet carefully to get the most out of your new unit. Thanks for selecting NADY AUDIO and the PS112 as your choice in speakers.

Ruggedly built, exceptional sound, most affordably priced – the ProPower Series™ from Nady Audio delivers the best value in small PA speakers

FEATURES AND SPECIFICATIONS

- Full range, 2-way speaker with 12" woofer, 5"x15" horn
- Peak program power rating: 300W(150W RMS)
- All horns with high compression piezo drivers
- Durable black carpet cover
- Heavy duty plastic protective corners
- Integrated recessed carrying handles for easy handling
- Binding post (banana jack) and two 1/4" (6.3 mm) jack inputs
- Base mount inserts for mounting on speaker stands
- Sensitivity (1W/1M): 91.5dB
- Weight: 35 lbs (15.9 Kg)
- Dimensions (WDH): 17"x 11.75"x 22.75" (43.2 x 29.8 x 57.8 cm)

WARNINGS IMPORTANT SAFETY INSTRUCTIONS

When using this speaker, basic precautions should always be taken, including the following:

- Read all instructions before using the product.
- This product may be capable of producing sound levels that could cause permanent hearing loss. Do not operate for a long period of time at a high volume level or at a level that is uncomfortable. If you experience any hearing loss or ringing in the ears, you should consult an audiologist.
- To avoid damage to the drivers, never overload the speaker.
- To avoid the risk of fire, do not ever expose the speaker to a source of naked flames. Also, it should be located away from heat sources such as radiators, heat vents, or other devices (including amplifiers) that produce heat.
- The product should be positioned so that proper ventilation is maintained.
- This speaker is designed for indoor use only. Do not expose to weather or high humidity, rain, etc.
- Care should be taken so that objects do not fall into, and liquids are not spilled through, the enclosure's openings. Do not place containers of liquids on the speaker.
- Don't place any heavy appliance or object (>130lbs/60kg) on the speaker enclosure.
- This unit is to be installed by qualified personnel only.
- This speaker is only to be used with power amplifiers complying with the safety requirement of EN or IEC60065.
- This product should be serviced by qualified service personnel if:
 - A. Objects have fallen into, or liquid has been spilled onto the product.
 - B. The product has been exposed to rain.
 - C. The product does not appear to operate normally or exhibits a marked change in performance.
 - D. The product has been dropped, or the enclosure damaged.
- Do not attempt to service this unit. All servicing should be referred to qualified service personnel.

SPECIFICATIONS TECHNICAL DATA

IMPEDANCE RESPONSE & PARAMETERS

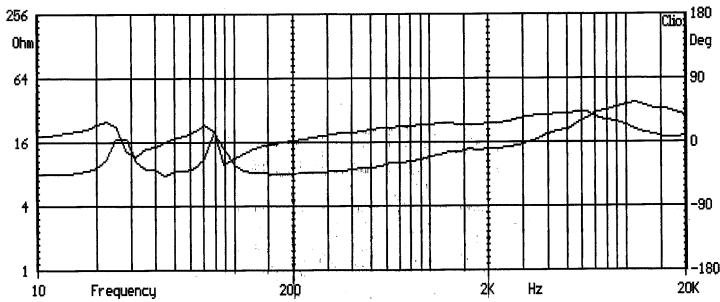

MLS ANALYSIS

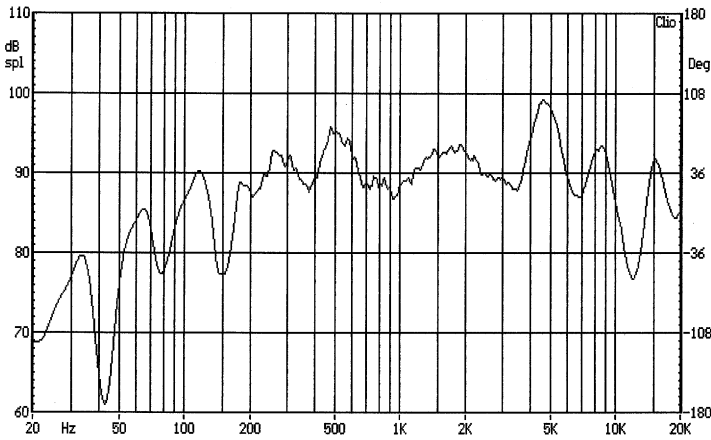

IMPEDANCE RESPONSE

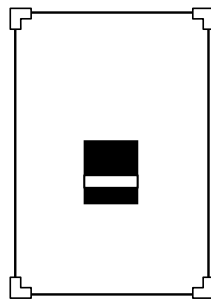
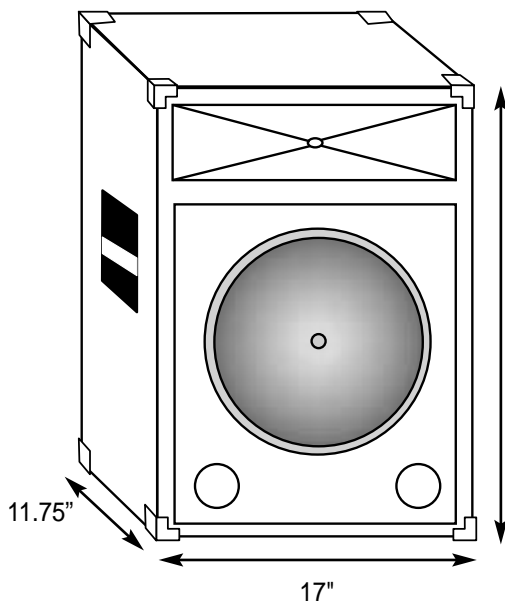
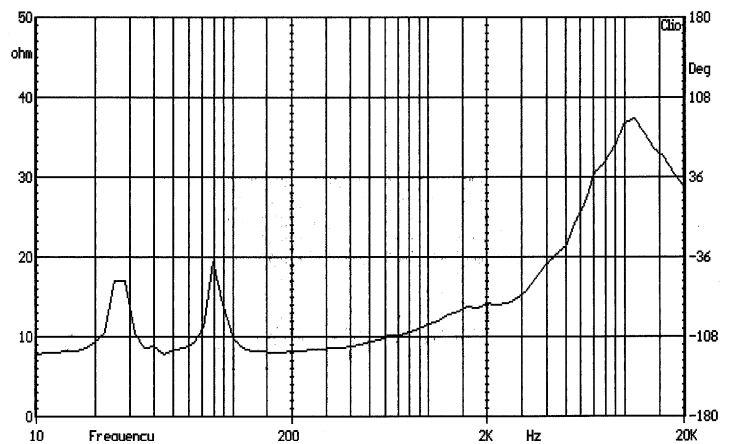

Side View

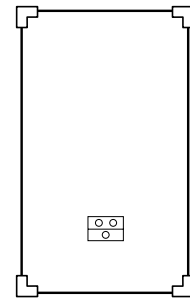

Back View

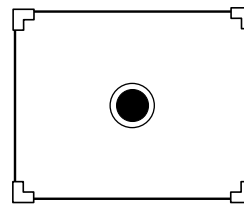

Bottom View

SERVICE FOR YOUR NADY AUDIO PRODUCT

(U.S.) Should your NADY AUDIO product require service, please contact the Nady Service Department via telephone at (510) 652-2411 or e-mail at service@nady.com.

(International) For service, please contact the NADY AUDIO distributor in your country through the dealer from whom you purchased this product.



NADY SYSTEMS, INC. • 6701 SHELLMOUND STREET, EMERYVILLE, CA 94608
Tel: 510.652.2411 • Fax: 510.652.5075 • www.nady.com